



EXCEED  
*expectations*

HEATED &  
NON-HEATED  
TOWEL RAILS



EXCEED  
*expectations*





Radiant Australia have been at the forefront of providing quality heated towel rails and quality design for more than a decade. Our products were once considered something of a luxury item, and have now become a standard inclusion in modern bathroom designs. Our heated towel rails are easy to install and are available in a number of different sizes and finishes to suit any bathroom style or colour. You do not have to compromise with Radiant - we have a strong focus on quality, backed by first class customer service, whilst retaining a competitive position in the market.



## EXCELLENCE AT A GLANCE

---

Mirror Polished and Satin Brushed manufactured from 304 grade stainless steel

---

Coloured finishes manufactured from 201 grade stainless steel

---

IP55 rated

---

Hard wired or plug in options included on all heated towel rails

---

Mirror Polished & Satin Brushed covered by a 10 year warranty

---

Coloured Coatings are covered by a 2 year warranty

---

# BE INSPIRED *options*

Our full collection can be integrated to achieve a designer look for any bathroom, creating a true highlight within a home and backed by our ten year warranty. With an array of finishes; from our timeless polished stainless steel, which are the perfect match to any chrome bathroom fittings, ever popular Matt Black, to our newly added Gun Metal Grey, Oil Rubbed Bronze and Brushed Gold. All towel rails have been Australian Safety Approved and can be either plugged in or hard wired creating no visible wiring. Power outlets can be requested in either a left or right configuration and can be inverted so that the cable can exit from the top if required, giving you an array of bathroom options.



## FINISHES



Mirror Polished



Satin Brushed



Matt Black



Gun Metal Grey



Oil Rubbed Bronze



Brushed Gold



STYLES

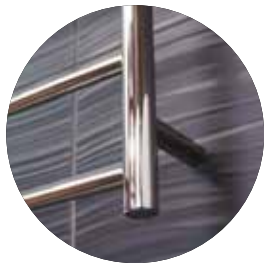

Ladder  
Round & Square



Single  
Round & Square



Single  
Vertical Rails



Floor to  
Ceiling



Freestanding

ACCESSORIES



Touch Screen Timer

ROUND NON-HEATED

SQUARE NON-HEATED

SINGLE HEATED & NON-HEATED



*round*  
NON-HEATED

ROUND BAR HEATED

SQUARE BAR HEATED

TOUCH SCREEN TIMER

Our Round Non-Heated Collection of towel rails is all about elegant design to enhance your stylish bathroom setting. This collection is available in a number of different sizes and finishes.



ROUND NON-HEATED

SQUARE NON-HEATED

SINGLE HEATED & NON-HEATED



*square*  
NON-HEATED



ROUND BAR HEATED

SQUARE BAR HEATED

TOUCH SCREEN TIMER



Our Square Non-Heated Collection of towel rails offer an opportunity to accent your bathroom with contemporary crisp lines. This collection is available in a number of different sizes and finishes.



ROUND NON-HEATED

SQUARE NON-HEATED

SINGLE HEATED & NON-HEATED



*single*  
HEATED &  
NON-HEATED

Our Single Towel Rail Collection is the perfect way to add the finishing touch to your bathroom giving flexibility using multiple rails. All Single Bar Heated Towel Rails require a transformer and a fixing kit suitable for upto 4 rails and are a low 12 volts allowing them to be placed anywhere in the bathroom including the shower.

SHAPES

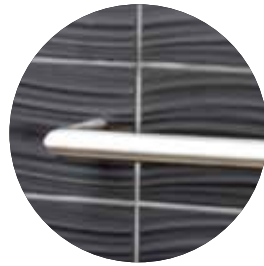

Round Bar

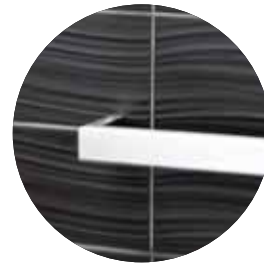

Square Bar



ASPEN  
Single Flat Faced  
with Curved  
Fixing Arm



VAIL  
Single Square  
Bar with Rounded  
Corners

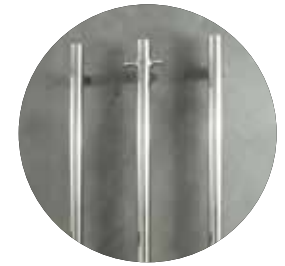

Single  
Vertical Rails



ROUND NON-HEATED

SQUARE NON-HEATED

SINGLE HEATED & NON-HEATED



*round*  
HEATED

## ROUND BAR HEATED

## SQUARE BAR HEATED

## TOUCH SCREEN TIMER

Create a little luxury with our Round Heated Collection. Designed to give your towels space to dry, in a wealth of sizes and finishes to suit any bathroom space. All of our heated towel rails are also IP55 rated meaning that they can even go in the entrance to a shower or above a bath.



ROUND NON-HEATED

SQUARE NON-HEATED

SINGLE HEATED & NON-HEATED



*square*  
HEATED

ROUND BAR HEATED

SQUARE BAR HEATED

TOUCH SCREEN TIMER



For the ultimate in luxury our Square Heated Collection is a great addition to any modern and geometric shaped bathroom styling. And for those colder winter months, a heated towel rail can dry your wet towels quickly and conveniently. This collection is available in a number of different sizes and finishes, including three new options – Gun Metal Grey, Oil Rubbed Bronze and Brushed Gold.



ROUND NON-HEATED

SQUARE NON-HEATED

SINGLE HEATED & NON-HEATED



TOUCH SCREEN  
*timer*



A Digital Timer Switch is an ideal solution for automatically controlling your heated towel rail. No longer will you forget to turn it on, or leave the rail on all day because you can simply program the timer to turn your towel rail on before you get up and turn it off a few hours later when the wet towels have dried.

- 16 Amp rating (suitable for all heated towel rails)
- Blue backlit display which illuminates for easy programming
- Manual or program mode
- Timing: 2 on and 2 off times per day
- 5/2 or 7 day timing mode
- Keypad lock function
- 120mm x 80mm x 18mm (fits into a standard wall box/bracket)
- 2 year warranty



STANDARD PLASTIC CASING



White

PREMIUM GLASS FRONTED



Black



Silver



White

# NON-HEATED *specifications*

- Mirror Polished and Satin Brushed manufactured from 304 grade stainless steel
- Coloured finishes manufactured from 201 grade stainless steel
- Mirror Polished & Satin Brushed covered by a 10 year warranty
- Coloured Coatings are covered by a 2 year warranty

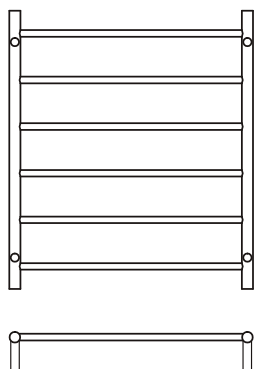

## LTR01

Round bar / 6 evenly spaced bars  
 Vertical Bars 32mm diameter  
 Horizontal bars 19mm diameter  
 112mm from wall  
 Available in various widths: 500, 600, 700, 800

CODE	Size (mm)	Finish
LTR01-500	500x830	Polished
LTR01-600	600x830	Polished
LTR01-700	700x830	Polished
LTR01- 800	800x830	Polished
BRU-LTR01-700	700x830	Satin Brushed
BLTR01 - 700	700x830	Matt Black
GMG-LTR01	700x830	Gun Metal Grey

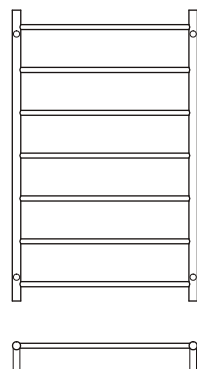

## LTR02

Round bar / 7 evenly spaced bars  
 Vertical Bars 32mm diameter  
 Horizontal bars 19mm diameter  
 112mm from wall  
 Available in various widths: 500, 600, 700, 800

CODE	Size (mm)	Finish
LTR02-500	500x1130	Polished
LTR02-600	600x1130	Polished
LTR02-700	700x1130	Polished
LTR02- 800	800x1130	Polished
BRU-LTR02-700	700x1130	Satin Brushed
BLTR02-700	700x1130	Matt Black

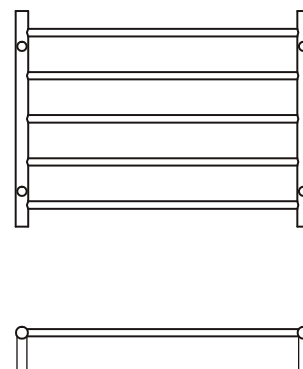

## LTR03

Round bar / 5 evenly spaced bars  
 Vertical Bars 32mm diameter  
 Horizontal bars 19mm diameter  
 112mm from wall  
 Available in various widths: 600, 750

CODE	Size (mm)	Finish
LTR03-600	600x550	Polished
LTR03-750	750x550	Polished
BRU-LTR03 -750	750x550	Satin Brushed
BLTR03-700	750x550	Matt Black



## LTR430

Round bar / 10 bars with a central gap  
 Vertical Bars 32mm diameter  
 Horizontal bars 19mm diameter  
 112mm from wall

CODE	Size (mm)	Finish
LTR430	430x1100	Polished
BLTR430	430x1100	Matt Black

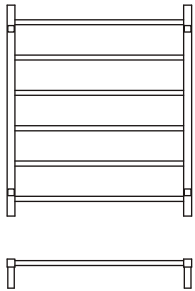

### SLTR01

Square bar / 6 evenly spaced bars  
 Vertical bars 30mm x 30mm  
 Horizontal bars 19mm x 19mm  
 110mm from wall

Available in various widths: 500, 600, 700, 800

CODE	Size (mm)	Finish
SLTR01-500	500x830	Polished
SLTR01-600	600x830	Polished
SLTR01-700	700x830	Polished
SLTR01-800	800x830	Polished
BSLTR01-700	700x830	Matt Black
GMG-SLTR01	700x830	Gun Metal Grey



### SLTR02

Square bar / 7 evenly spaced bars  
 Vertical bars 30mm x 30mm  
 Horizontal bars 19mm x 19mm  
 110mm from wall

Available in various widths: 500, 600, 700, 800

CODE	Size (mm)	Finish
SLTR02-500	500x1130	Polished
SLTR02-600	600x1130	Polished
SLTR02-700	700x1130	Polished
SLTR02-800	800x1130	Polished
BSLTR02-700	700x1130	Matt Black

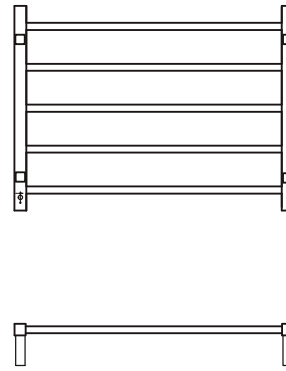

### SLTR03

Square bar / 5 evenly spaced bars  
 Vertical bars 30mm x 30mm  
 Horizontal bars 19mm x 19mm  
 110mm from wall

Available in various widths: 600, 750

CODE	Size (mm)	Finish
SLTR03-600	600x550	Polished
SLTR03-750	750x550	Polished



# SINGLE HEATED & NON HEATED specifications

- Mirror Polished and Satin Brushed manufactured from 304 grade stainless steel
- Coloured finishes manufactured from 201 grade stainless steel
- IP55 rated
- Mirror Polished & Satin Brushed covered by a 10 year warranty
- Coloured Coatings are covered by a 2 year warranty

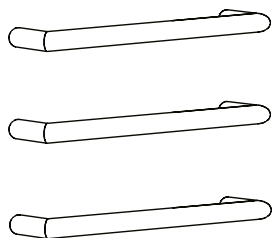

## SBRTTR

Single Round bar  
Can be used as heated and non-heated  
Available in various widths: 500, 650, 800  
Distance from the wall: 80mm

CODE	Watt	Size (mm)	Finish
SBRTTR - 500	12W	80x500	Polished
SBRTTR - 650	15W	80x650	Polished
SBRTTR - 800	18W	80x800	Polished
BRU- SBRTTR-500	12W	80x500	Satin Brushed
BRU-SBRTTR-650	15W	80x650	Satin Brushed
BRU-SBRTTR-800	18W	80x800	Satin Brushed
BSBRTTR - 500	12W	80x500	Matt Black
BSBRTTR - 650	15W	80x650	Matt Black
BSBRTTR - 800	18W	80x800	Matt Black
GMG-SBRTTR 650	15W	80x650	Gun Metal Grey
GMG-SBRTTR 800	18W	80x800	Gun Metal Grey
TTR 300	120 watt transformer for up to 4 rails		
SB-FIX	Single bar fixing rail for up to 4 rails		

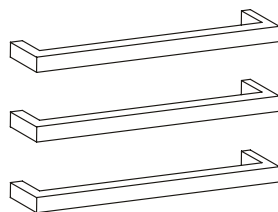

## SBSTR

Single Square bar  
Can be used as heated and non-heated  
Available in various widths: 500, 650, 800  
Distance from the wall: 80mm

CODE	Watt	Size (mm)	Finish
SBSTR - 500	12W	80x500	Polished
SBSTR - 650	12W	80x650	Polished
SBSTR - 800	15W	80x800	Polished
BRU- SBSTR-500	12W	80x500	Satin Brushed
BRU-SBSTR-650	12W	80x650	Satin Brushed
BRU-SBSTR-800	15W	80x800	Satin Brushed
BSBSTTR - 500	12W	80x500	Matt Black
BSBSTTR - 650	12W	80x650	Matt Black
BSBSTTR - 800	15W	80x800	Matt Black
TTR 300	120 watt transformer for up to 4 rails		
SB-FIX	Single bar fixing rail for up to 4 rails		

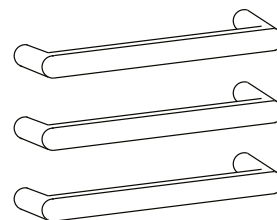

## ASPEN

Single Flat Faced with Curved Fixing Arm  
Can be used as heated and non-heated  
Available in various widths: 650, 800  
Distance from the wall: 80mm

CODE	Watt	Size (mm)	Finish
Aspen-650	15W	50x650	Polished
Aspen-800	18W	50x800	Polished
BRU-ASPEN-650	15W	50x650	Satin Brushed
BRU-ASPEN-800	18W	50x800	Satin Brushed
BLK-ASPEN-650	15W	50x650	Matt Black
BLK-ASPEN-800	18W	50x800	Matt Black
TTR 300	120 watt transformer for up to 4 rails		
SB-FIX	Single bar fixing rail for up to 4 rails		

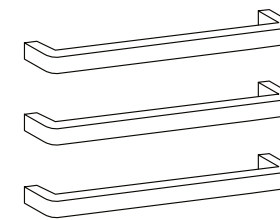

## VAIL

Single Square Bar with Rounded ends  
Can be used as heated and non-heated  
Available in various widths: 650, 800  
Distance from the wall: 80mm

CODE	Watt	Size (mm)	Finish
Vail-650	15W	80x650	Polished
Vail-800	18W	80x800	Polished
GMG-Vail 650	15W	80x650	Gun Metal Grey
GMG-Vail 800	18W	80x800	Gun Metal Grey
BRU-VAIL-650	12W	80x650	Satin Brushed
BRU-VAIL-800	15W	80x800	Satin Brushed
BLK-VAIL-650	12W	80x650	Matt Black
BLK-VAIL-800	15W	80x800	Matt Black
GLD-VAIL-650	12W	80x650	Brushed Gold
TTR 300	120 watt transformer for up to 4 rails		
SB-FIX	Single bar fixing rail for up to 4 rails		

**KEY** Polished BRU- (Satin Brushed) B (Matt Black) GMG- (Gun Metal Grey) ORB- (Oil Rubbed Bronze) GLD- Brushed Gold

NOTE: Not all products are available in all finishes. If not listed in the specifications it is not currently available.

**If heating any of our single bars, including verticals, you will need to purchase the following:**

TTR300 – 120 watt transformer for up to 4 rails

SB-FIX – Single bar fixing rail (not required if installing as non-heated) for up to 4 rails

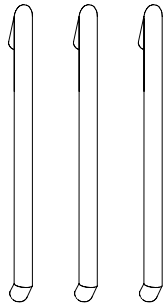

## VTR-950

Single Vertical Round Bar  
Can be used as heated and non-heated  
Distance from the wall: 90mm

CODE	Watt	Size (mm)	Finish
VTR-950	25W	40x950	Polished
BRU-VTR-950	25W	40x950	Satin Brushed
BLK-VTR-950	25W	40x950	Matt Black
GMG-VTR-950	25W	40x950	Gun Metal Grey
GLD-VTR-950	25W	40x950	Brushed Gold
TTR 300	120 watt transformer for up to 4 rails		
SB-FIX	Single bar fixing rail for up to 4 rails		

### OPTIONAL HOOKS ARE SOLD SEPERATELY

VTR-HOOK	15x110	Polished
BRU-VTR-HOOK	15x110	Satin Brushed
BLK-VTR-HOOK	15x110	Matt Black
GMG-VTR-HOOK	15x110	Gun Metal Grey
GLD-VTR-HOOK	15x110	Brushed Gold

# ROUND HEATED specifications

- Mirror Polished and Satin Brushed manufactured from 304 grade stainless steel
- Coloured finishes manufactured from 201 grade stainless steel
- IP55 rated (oil rubbed brass is IP54 rated)
- Hard wired or plug in options available on all heated towel rails
- Can be mounted upside down
- Mirror Polished and Satin Brushed covered by a 10 year warranty
- Coloured Coatings are covered by a 2 year warranty

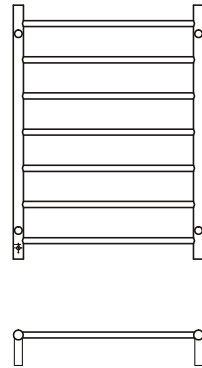

## RTR01

Round bar / Height 800mm  
7 evenly spaced bars / 85 Watts  
Vertical bars 32mm diameter  
Horizontal bars 19mm diameter  
112mm from wall  
Cable length 1.4m

CODE	Size (mm)	Finish
RTR01LEFT	600x800	Polished
RTR01RIGHT	600x800	Polished
BRU-RTR01LEFT	600x800	Satin Brushed
BRU-RTR01RIGHT	600x800	Satin Brushed
BRTR01LEFT	600x800	Matt Black
BRTR01RIGHT	600x800	Matt Black
GMG-RTR01LEFT	600x800	Gun Metal Grey
GMG-RTR01RIGHT	600x800	Gun Metal Grey
ORB-RTR01LEFT	600x800	Oil Rubbed Bronze
ORB-RTR01RIGHT	600x800	Oil Rubbed Bronze
GLD-RTR01LEFT	600x800	Brushed Gold
GLD-RTR01RIGHT	600x800	Brushed Gold



## RTR02

Round bar / Height 1100mm  
10 bars with a central gap / 125 Watts  
Vertical bars 32mm diameter  
Horizontal bars 19mm diameter  
112mm from wall  
Cable length 1.4m

CODE	Size (mm)	Finish
RTR02LEFT	600x1100	Polished
RTR02RIGHT	600x1100	Polished
BRU-RTR02LEFT	600x1100	Satin Brushed
BRU-RTR02RIGHT	600x1100	Satin Brushed
BRTR02LEFT	600x1100	Matt Black
BRTR02RIGHT	600x1100	Matt Black
GMG-RTR02LEFT	600x1100	Gun Metal Grey
GMG-RTR02RIGHT	600x1100	Gun Metal Grey

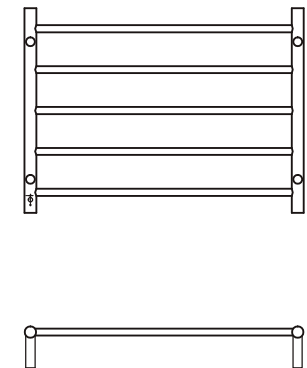

## RTR03

Round bar / Height 550mm  
5 evenly spaced bars / 75 Watts  
Vertical bars 32mm diameter  
Horizontal bars 19mm diameter  
112mm from wall  
Cable length 1.4m

CODE	Size (mm)	Finish
RTR03LEFT	750x550	Polished
RTR03RIGHT	750x550	Polished
BRU-RTR03LEFT	750x550	Satin Brushed
BRU-RTR03RIGHT	750x550	Satin Brushed
BRTR03LEFT	750x550	Matt Black
BRTR03RIGHT	750x550	Matt Black

# ROUND HEATED *specifications*

- Mirror Polished and Satin Brushed manufactured from 304 grade stainless steel
- Coloured finishes manufactured from 201 grade stainless steel
- IP55 rated (oil rubbed brass is IP54 rated)
- Hard wired or plug in options available on all heated towel rails
- Can be mounted upside down
- Mirror Polished & Satin Brushed covered by a 10 year warranty
- Coloured Coatings are covered by a 2 year warranty

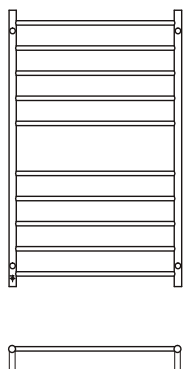

## RTR04

Round bar / Height 1200mm  
 10 bars with a central gap / 130 Watts  
 Vertical bars 32mm diameter  
 Horizontal bars 19mm diameter  
 112mm from wall  
 Cable length 1.4m

CODE	Size (mm)	Finish
RTR04LEFT	750x1200	Polished
RTR04RIGHT	750x1200	Polished
BRU-RTR04LEFT	750x1200	Satin Brushed
BRU-RTR04RIGHT	750x1200	Satin Brushed
BRTR04LEFT	750x1200	Matt Black
BRTR04RIGHT	750x1200	Matt Black

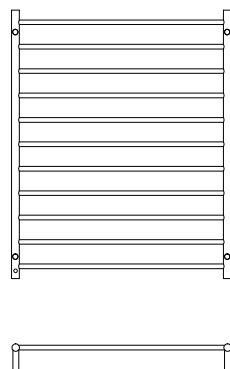

## RTR05

Round bar / Height 1100mm  
 11 evenly spaced bars / 180 Watts  
 Vertical bars 32mm diameter  
 Horizontal bars 19mm diameter  
 112mm from wall  
 Cable length 1.4m

CODE	Size (mm)	Finish
RTR05LEFT	900x1100	Polished
RTR05RIGHT	900x1100	Polished

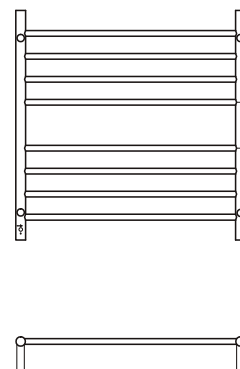

## RTR06

Round bar / Height 750mm  
 8 bars with a central gap / 125 Watts  
 Vertical bars 32mm diameter  
 Horizontal bars 19mm diameter  
 112mm from wall  
 Cable length 1.4m

CODE	Size (mm)	Finish
RTR06LEFT	750x750	Polished
RTR06RIGHT	750x750	Polished
BRU-RTR06LEFT	750x750	Satin Brushed
BRU-RTR06RIGHT	750x750	Satin Brushed
BRTR06LEFT	750x750	Matt Black
BRTR06RIGHT	750x750	Matt Black
GMG-RTR06LEFT	750x750	Gun Metal Grey
GMG-RTR06RIGHT	750x750	Gun Metal Grey

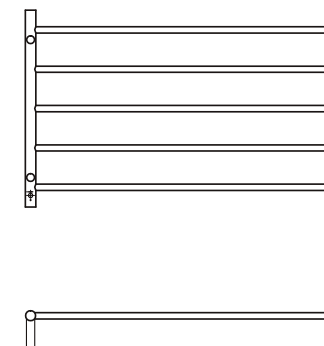

## RTR07

Round bar / Height 600mm  
 5 evenly spaced bars / 80 Watts  
 Vertical bars 32mm diameter  
 Horizontal bars 19mm diameter  
 112mm from wall  
 Cable length 1.4m

CODE	Size (mm)	Finish
RTR07LEFT	950x600	Polished
RTR07RIGHT	950x600	Polished
BRU-RTR07LEFT	950x600	Satin Brushed
BRU-RTR07RIGHT	950x600	Satin Brushed
BRTR07LEFT	950x600	Matt Black
BRTR07RIGHT	950x600	Matt Black

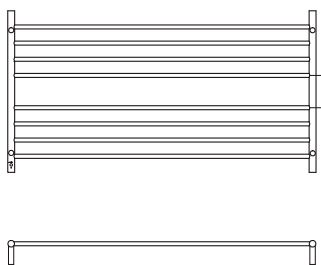

## RTR09

Round bar / Height 750mm  
 8 bars with a central gap / 125 Watts  
 Vertical bars 32mm diameter  
 Horizontal bars 19mm diameter  
 112mm from wall  
 Cable length 1.4m

CODE	Size (mm)	Finish
RTR09LEFT	1300x750	Polished
RTR09RIGHT	1300x750	Polished

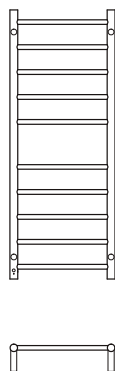

## RTR430

Round bar / Height 1100mm  
 10 bars with a central gap / 80 Watts  
 Vertical bars 32mm diameter  
 Horizontal bars 19mm diameter  
 112mm from wall  
 Cable length 1.4m

CODE	Size (mm)	Finish
RTR430LEFT	430x1100	Polished
RTR430RIGHT	430x1100	Polished
BRU-RTR430LEFT	430x1100	Satin Brushed
BRU-RTR430RIGHT	430x1100	Satin Brushed
BRTR430LEFT	430x1100	Matt Black
BRTR430RIGHT	430x1100	Matt Black

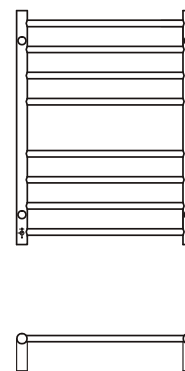

## RTR530

Round bar / Height 700mm  
 8 bars with a central gap / 65 Watts  
 Vertical bars 32mm diameter  
 Horizontal bars 19mm diameter  
 112mm from wall  
 Cable length 1.4m

CODE	Size (mm)	Finish
RTR530LEFT	530x700	Polished
RTR530RIGHT	530x700	Polished
BRU-RTR530LEFT	530x700	Satin Brushed
BRU-RTR530RIGHT	530x700	Satin Brushed
BRTR530LEFT	530x700	Matt Black
BRTR530RIGHT	530x700	Matt Black

### Also available in a NON-HEATED version

CODE	Size (mm)	Finish
BLTR530	530x700	Matt Black

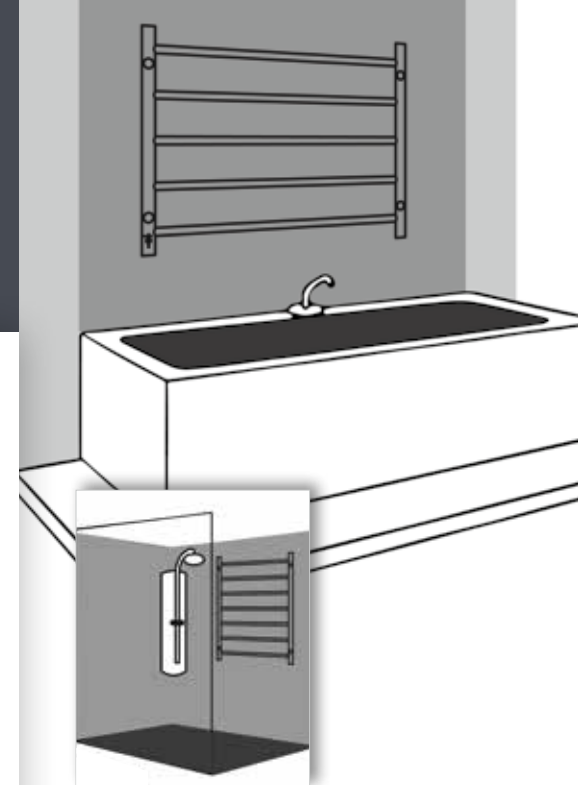

## LOW VOLTAGE SINGLE BARS

Low voltage 12V towel rail  
 The towel rail is supplied with a three metre cord and must be wired by a licensed electrician via the 12V transformer  
 Transformer is supplied with the rail

CODE	Watts	Size (mm)	Finish
12V-RTR01LEFT	85W	600x800	Polished
12V-RTR01RIGHT	85W	600x800	Polished
12V-RTR430LEFT	80W	430x1100	Polished
12V-RTR430RIGHT	80W	430x1100	Polished
12V-RTR03LEFT	75W	750x550	Polished
12V-RTR03RIGHT	75W	750x550	Polished
12V-STR01LEFT	80W	600x800	Polished
12V-STR01RIGHT	80W	600x800	Polished
12V-BRTR01LEFT	75W	600x800	Matt Black
12V-BRTR01RIGHT	75W	600x800	Matt Black

# SQUARE HEATED *specifications*

- Mirror Polished and Satin Brushed manufactured from 304 grade stainless steel
- Coloured finishes manufactured from 201 grade stainless steel
- IP55 rated (oil rubbed brass is IP54 rated)
- Hard wired or plug in options available on all heated towel rails
- Can be mounted upside down
- Mirror Polished & Satin Brushed covered by a 10 year warranty
- Coloured Coatings are covered by a 2 year warranty

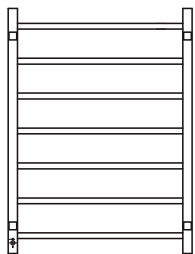

## STR01

Square bar / Height 800mm  
7 evenly spaced bars / 80 Watts  
Vertical bars 30mm x 30mm  
Horizontal bars 19mm x 19mm  
110mm from wall  
Cable length 1.4m

CODE	Size (mm)	Finish
STR01LEFT	600x800	Polished
STR01RIGHT	600x800	Polished
BRU - STR01LEFT	600x800	Satin Brushed
BRU - STR01RIGHT	600x800	Satin Brushed
BSTR01LEFT	600x800	Matt Black
BSTR01RIGHT	600x800	Matt Black
GMG - STR01LEFT	600x800	Gun Metal Grey
GMG - STR01RIGHT	600x800	Gun Metal Grey
ORB - STR01LEFT	600x800	Oil Rubbed Bronze
ORB - STR01RIGHT	600x800	Oil Rubbed Bronze

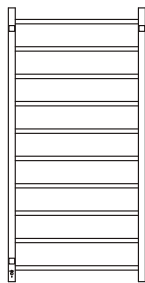

## STR02

Square bar / Height 1200mm  
10 evenly spaced bars / 130 Watts  
Vertical bars 30mm x 30mm  
Horizontal bars 19mm x 19mm  
110mm from wall  
Cable length 1.4m

CODE	Size (mm)	Finish
STR02LEFT	600x1200	Polished
STR02RIGHT	600x1200	Polished

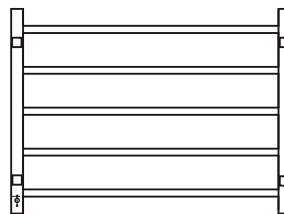

## STR03

Square bar / Height 550mm  
5 evenly spaced bars / 75 Watts  
Vertical bars 30mm x 30mm  
Horizontal bars 19mm x 19mm  
110mm from wall  
Cable length 1.4m

CODE	Size (mm)	Finish
STR03LEFT	750x550	Polished
STR03RIGHT	750x550	Polished
BSTR03LEFT	750x550	Matt Black
BSTR03RIGHT	750x550	Matt Black

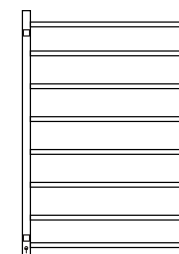

## STR05

Square bar / Height 1000mm  
8 evenly spaced bars / 120 Watts  
Vertical bars 30mm x 30mm  
Horizontal bars 19mm x 19mm  
110mm from wall  
Cable length 1.4m

CODE	Size (mm)	Finish
STR05LEFT	800x1000	Polished
STR05RIGHT	800x1000	Polished
BSTR05LEFT	800x1000	Matt Black
BSTR05RIGHT	800x1000	Matt Black



# FREESTANDING *specifications*

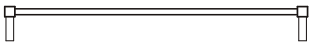

## STR06

Square bar / Height 750mm  
 7 evenly spaced bars / 125 Watts  
 Vertical bars 30mm x 30mm  
 Horizontal bars 19mm x 19mm  
 110mm from wall  
 Cable length 1.4m

CODE	Size (mm)	Finish
STR06LEFT	950x750	Polished
STR06RIGHT	950x750	Polished

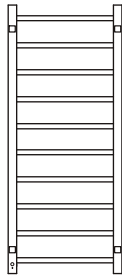

## STR430

Square bar / Height 1100mm  
 10 evenly spaced bars / 80 Watts  
 Vertical bars 30mm x 30mm  
 Horizontal bars 19mm x 19mm  
 110mm from wall  
 Cable length 1.4m

CODE	Size (mm)	Finish
STR430LEFT	430x1000	Polished
STR430RIGHT	430x1000	Polished
BSTR430LEFT	430x1000	Matt Black
BSTR430RIGHT	430x1000	Matt Black

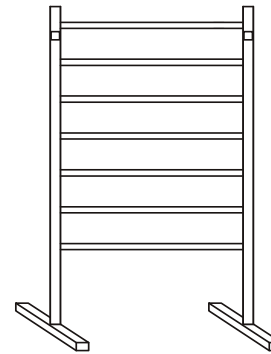

## FSTR01

Freestanding / Height 1000mm  
 7 evenly spaced bars / 90 Watts  
 Vertical bars 38mm x 24mm  
 Horizontal bars 19mm diameter  
 Adjustable feet / Plug in on RIGHT side on/off switch  
 Cable length 1.4m  
 Feet length 360 mm

CODE	Size (mm)	Finish
FSTR01	600x1000	Polished



# FLOOR TO CEILING specifications

- Mirror Polished and Satin Brushed manufactured from 304 grade stainless steel
- Coloured finishes manufactured from 201 grade stainless steel
- Mirror Polished & Satin Brushed covered by a 10 year warranty
- Coloured finishes covered by a 2 year warranty

# TIMER specifications

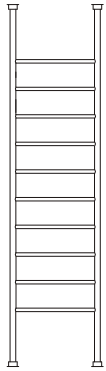

## FC-2400

Round bar / Height 2400mm / 10 evenly spaced bars  
Vertical Bars 32mm diameter  
Horizontal Bars 19mm  
Available in various widths: 500 / 600 / 700  
Floor-Ceiling only available in Mirror Polished

CODE	Watt	Size (mm)	Finish
FC-2400X500	110W	500x2400	Polished
FC-2400X600	125W	600x2400	Polished
FC-2400X700	145W	700x2400	Polished

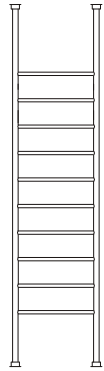

## FC-2500

Round bar / Height 2500mm / 10 evenly spaced bars  
Vertical Bars 32mm diameter  
Horizontal Bars 19mm  
Available in various widths: 500 / 600 / 700  
Floor-Ceiling only available in Mirror Polished

CODE	Watt	Size (mm)	Finish
FC-2500X500	110W	500x2500	Polished
FC-2500X600	130W	600x2500	Polished
FC-2500X700	145W	700x2500	Polished



## FC-2700

Round bar / Height 2700mm / 10 evenly spaced bars  
Vertical Bars 32mm diameter  
Horizontal Bars 19mm  
Available in various widths: 500 / 600 / 700  
Floor-Ceiling only available in Mirror Polished

CODE	Watt	Size (mm)	Finish
FC-2700X500	110W	500x2700	Polished
FC-2700X600	125W	600x2700	Polished
FC-2700X700	145W	700x2700	Polished



## Touch Screen Timers

16 Amp rating (suitable for all heated towel rails)  
Manual or program mode  
120mm x 80mm x 18mm (fits into a standard wall box/ bracket)  
2 year warranty  
Please see the full specifications at the front of the brochure

### STANDARD DIGITAL TOUCH SCREEN TIMERS

TS8100W-TIM-V Vertical Mounted - White  
TS8100W-TIM-H Horizontal Mounted - White

### RADIANT DIGITAL GLASS FRONTED TOUCH SCREEN TIMERS

GTSW-TIM-V Vertical Mounted - White  
GTSB-TIM-V Vertical Mounted - Black  
GTSS-TIM-V Vertical Mounted - Silver

# SINGLE TOWEL RAIL *installation*

Metal fixing bracket for simple pre-wiring of Radiant single bar towel rails. If installing on a brick wall, first install a suitable conduit from the ceiling to the position of the lowest towel rail. Ensure that the wiring holes in the bracket are positioned directly over the conduit. Mark the desired spacing and pre-drill holes in the conduit prior to fixing the bar in position on the wall. If installing on a timber or metal framed stud wall, a conduit is not essential. The transformer should be located as close to the top of the conduit as possible

NOTE: Use a spirit level or laser to ensure the bar is perfectly vertical when installed. Please visit [radiantaustralia.com.au](http://radiantaustralia.com.au) for a complete downloadable installation guide.

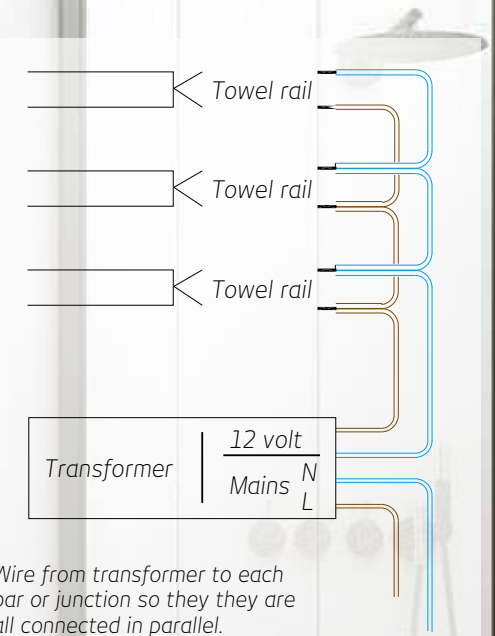
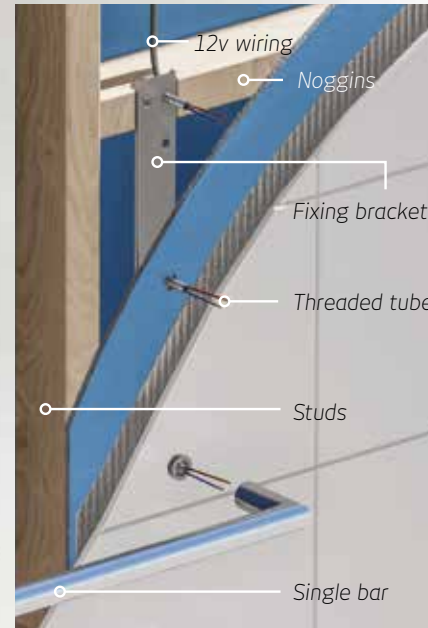
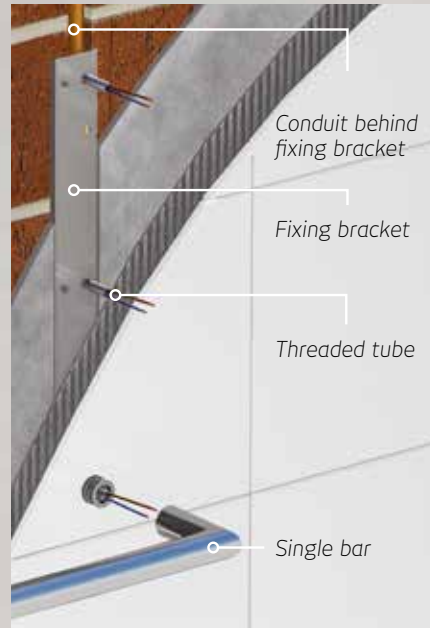

# SINGLE VERTICAL TOWEL RAIL *installation*

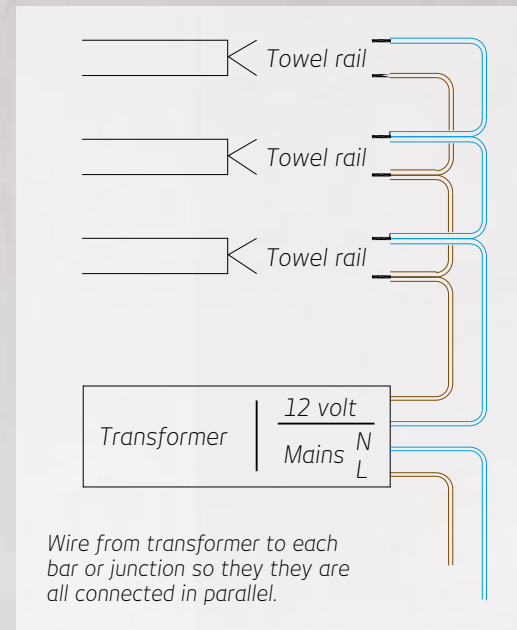
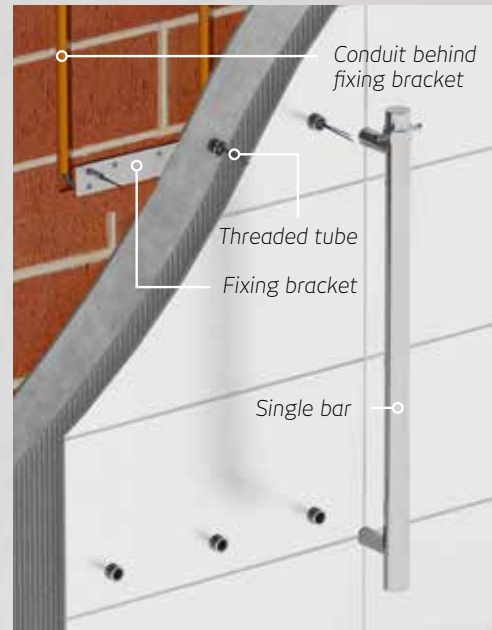
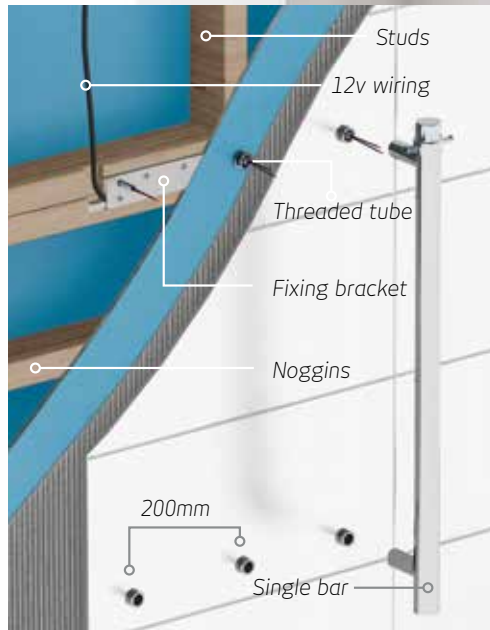

## LADDER WIRING *options*

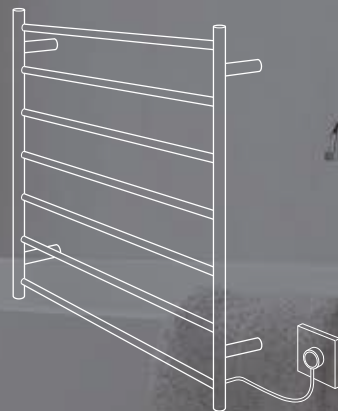

PLUG IN



HARD WIRED CONCEALED CABLE

- Wall switch or timer.
- A concealed cable (1.4m) in wall or conduit to separate switch!
- Cable connection available left OR right side - please specify requirement when ordering.
- 35mm
- Fifth leg concealment tube

The RTR and STR series heated towel rails are supplied with a moulded plug for 'soft wiring' AND a concealed fixing kit for 'hard wiring'. Please see drawings.

For concealed wiring, a provision needs to be made to connect the towel rail via a switch or timer switch as per the drawing. Depending on your preferred switch position the towel rail can be mounted upside down if required.

NOTE: Hard wired installation must be carried out by a licenced electrician. The Radiant Towel Rail range are manufactured in accordance with Australian Standards - SAA Certificate of Approval number V07911. All rails are covered with a 10 year warranty for construction / heating element and the coating on coloured rails is covered by a 2 year warranty.

Please visit [radiantaustralia.com.au](http://radiantaustralia.com.au) for a complete downloadable installation guide.

# your FAQ'S

## **How hot do the towel rails get?**

The temperature of our heated towel rails can vary depending on bathroom temperature and if they are operated with or without a towel. A folded towel will generally hold the heat and therefore the bars will be warmer than when operated without a towel. In general they should be hot enough to dry and warm the towels, but not too hot to cause any issues. As a guide they should get to around 50-60 degrees Celcius.

## **How long will delivery take?**

With local stock held in most states, deliver to metro stores should only take on average 1-3 business days, country stores may take a day or two longer depending on location and day/time of order.

## **How long is the cable?**

The cable on our standard range of 240V towel rails is approximately 1.4m long, but can be cut short or lengthened by the installing electrician. If purchasing a 12V towel rail, this will have a 3m cable.

## **Where can they be positioned in the bathroom?**

All Radiant Towel Rails are rated IP55, when hard wired, which is one of the highest ratings available for heated towel rails in Australia. This means the towel rail is protected against water jets from any direction. IP55 rating generally allows installation in very close proximity to the bath or shower when 'hard wired' (including above the bath) as long as they are wired to a switch which is positioned in 'Zone 3' as determined by the AUS wiring regulations. As bathroom designs vary greatly and as with any electrical appliance, please always

ask your builder to consult the current version of the AUS wiring regulations to confirm the exact position allowable.

## **What are the wiring options?**

Our towel rails can be plugged into a GPO/ Powerpoint, or hard wired to a standard switch or timer switch. They can also be wired back to the light/fan switch plate as long as they are connected to the power circuit.

## **Which side does the wire come from?**

Power outlets can be requested in either bottom left or right configurations. Please note that the wiring position is fixed and cannot be changed so it is important to order the correct side if the electrician has already done the 'pre-wiring' for the towel rail.

## **Can I get top wire outputs?**

The towel rails can be mounted upside down if the connection is preferable at the top and this in no way affects the warranty. I.e a bottom left can become a top right.

## **How do you hide the cable?**

All of our towel rails come with a standard moulded plug for 'soft wiring' and also a separate '5th leg' for concealment of the cable when 'hard wired'. This fifth leg attaches to the towel rail and sits flush against the wall (without fixing) making installation very straight forward. As the concealed fixing sits directly behind the vertical bar it is barely noticeable and therefore does not affect the aesthetic.

## **How high off the floor should they be mounted?**

This depends on the model chosen and the location. For example a smaller model such as an RTR03 would generally be mounted higher off the floor than a taller model such as an RTR04. However if mounted below a window,

it may be mounted lower than when the wall height is available.

## **What do I do if I am installing on a half tiled wall?**

The legs supplied with all ladder towel rails are 80mm in length. However 70mm or 90mm are available upon request.

## **How much do they cost to run?**

The wattages of our current range vary between 65W and 145W, so depending on the electricity tariff, they should cost on average between 1-3 cents per hour to operate.

## **Can you make custom sizes?**

Custom sizes are available for project orders of 50 units or more where a retailer wants to stock a specific custom size outside of our standard range. Please contact us for further information and pricing. Orders for 'one offs' are generally not viable due to the cost of set up and approvals.

## **Are the towel rails thermostatically controlled?**

No. Our towel rails have a fixed wattage which is not variable. Although the towel rails are designed to run continuously, if you wish to control the timing or heat output from the towel rail, it is possible to connect to our Standard Touch Screen Timer.

## **Do you wish to make a claim?**

Please send all claim requests to [claims@radiantheating.com.au](mailto:claims@radiantheating.com.au)

When your claim has been approved we will issue you with an RMA number which you MUST quote when you return the item.

Please note that all returns (excluding faulty items) will be subject to a 15% restocking fee. Goods will need to be returned, packaged for re-sale, to one of the Radiant Australia warehouses before a credit will be issued.

# WE ALSO SELL THE FOLLOWING:

## DIY UNDERFLOOR HEATING

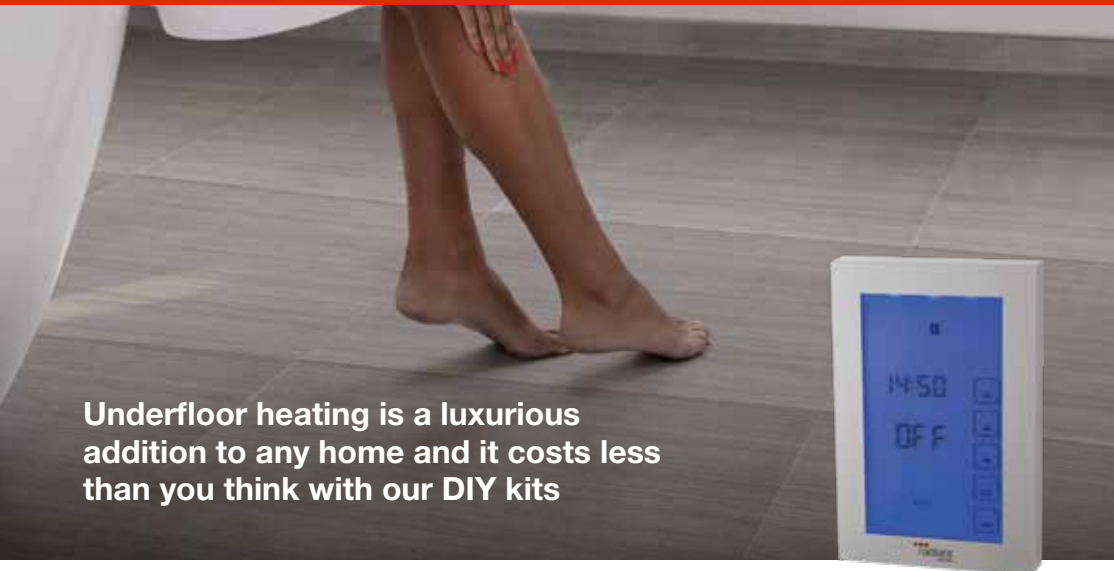

**Underfloor heating is a luxurious addition to any home and it costs less than you think with our DIY kits**

### Benefits

- On demand
- Asthma + allergy friendly
- Better bathroom design
- Dry floor
- Economical to run
- Temperature control
- Safe

Why not upgrade to a dual thermostat / timer if installing a heated towel rail along with underfloor heating?



Kits available for both In screed and Under tile to suit any project. Visit [radiantaustralia.com.au](http://radiantaustralia.com.au) for a full list of kit sizes and availability.

## TILE INSERT SHOWER GRATES

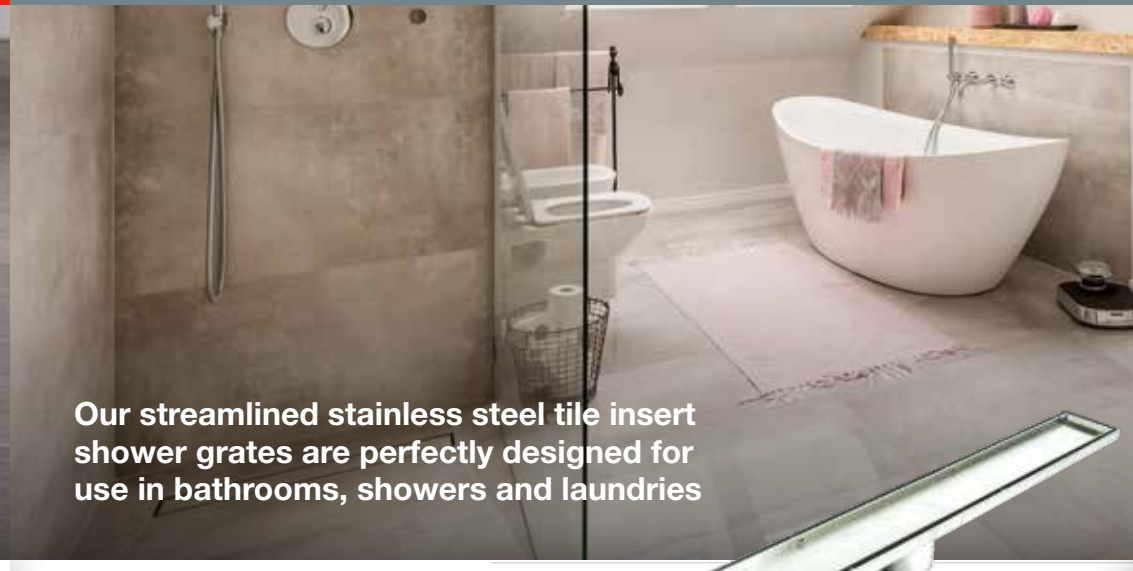

**Our streamlined stainless steel tile insert shower grates are perfectly designed for use in bathrooms, showers and laundries**

### Benefits

- 304 stainless steel
- Mirror polished to all exposed edges
- Wide range of sizes
- 7-year warranty
- Australian Watermark approved
- 12mm deep insert can accommodate up to 10mm tile + adhesive
- Available in both Mirror Polished and Matt Black finishes



Visit [radiantaustralia.com.au](http://radiantaustralia.com.au) for a full list of Shower Grate sizes and availability.

# THERMANICHE



Our prefabricated Thermaniches are great for storing items, and are useful in showers, bathrooms and wet rooms

## Benefits

- Lightweight
- Tile ready surface
- Waterproof
- Range of sizes
- High compressive strength
- Eco friendly
- Render + plaster ready surface



For more information about the full range of Thermasheet products visit our dedicated website [thermasheet.com.au](http://thermasheet.com.au). Visit [radiantaustralia.com.au](http://radiantaustralia.com.au) for a full list of Thermaniche sizes and availability.

# MIRROR DEMISTERS

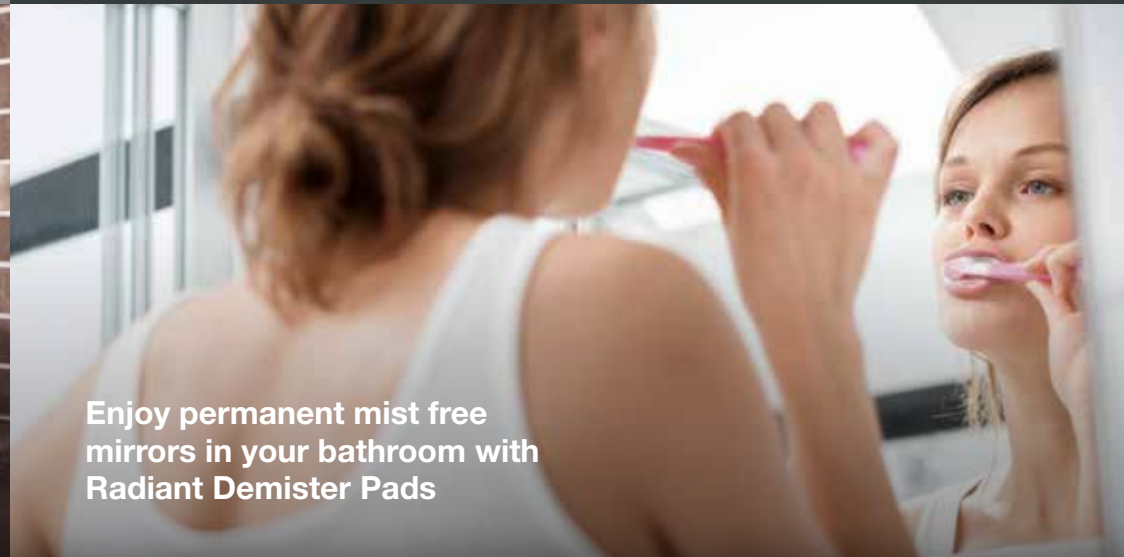

Enjoy permanent mist free mirrors in your bathroom with Radiant Demister Pads

## Benefits

- Developed and manufactured in the UK
- Simple to install and use
- Economical to run
- 10 year warranty
- Maintenance free
- IP44 rating
- Available in 5 stock sizes

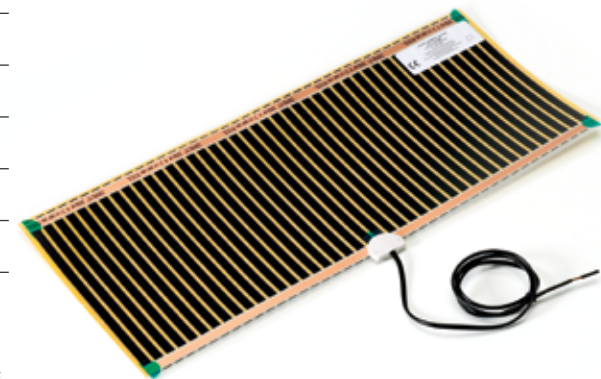

Visit [radiantaustralia.com.au](http://radiantaustralia.com.au) for a full list of Mirror Demister sizes and availability.



[radiantaustralia.com.au](http://radiantaustralia.com.au)

Unit 1 / 18 Profit Pass, Wangara, WA 6065.  
T 08 9302 4140  
E [info@radiantheating.com.au](mailto:info@radiantheating.com.au)



  
**radiant**  
AUSTRALIA